

FLEXEM FE9156 SPECIFICATIONS

Model: FE9156WE

Products Overview

Flexem industrial touch screen FE9000 series HMI, a new generation HMI, it extends Flexem touch screen 6000 series IIOT HMI function, industrial ABS economic frame, lost cost and high reliability. Fully new module, using more practical way, redesign front and higher color with higher resolution HMI.

Through selecting FLink IOT module to update to IOT HMI directly to enjoy complete Flexem IOT cloud service.

Through selecting FLink IOT module to update to IOT HMI directly to enjoy complete Flexem IOT cloud service.

Products Outlook





产品规格

Hardware Parameters	LCD	15.6" 16:9 TFT LCD Screen
	LCD View Angle (T/B/L/R)	85'/85'/85'/85'
	Resolution	1920×1080
	Color	16-bit
	Brightness	250 cd/m ²
	Backligh	LED
	LCD Life	50000 Hours
	Touch Screen	4-line Industrial Touch Screen
	CPU	4-core 1.2G Cortex-A53 Processor
	Memory	8GB EMMC FLash+1GB DDR3
	RTC	Built-in
	SD Card	Micro SD (TF) Card
	Ethernet	1-line 10M/100M adapative
	USB port	1 USB Slave 2.0 port, 1 USB Host 2.0 port
	Program Downloading	USB Slave/U-disc /Ethernet
	Serial Communication Ports	COM1/ COM3: RS232/RS485/RS422; COM2: RS485/RS422
Electric Specifications	Rated Power	< 18W
	Rated Voltage	DC24V,working range DC 18V~28V
	Power Protection	Power isolation module is used and protect from lightening and surging.
	Power Loss	< 5mS
	CE & RoHS	Confirms to EN61000-6-2:2005, EN61000-6-4:2007standard Confirms to RoHS, lightening& Surging±1KV, Group Pulse±2KV; Static contact: 4KV, Air discharge 8KV
Environment Specifications	Working Temperature	0~50°C
	Storage Temperature	-20~60°C
	Anti-violet	Prohibit to work under strong violet environment such as direct sunshine.
	Environment Humidity	10~90%RH(non condensate)
	Anti-vibration	10~25Hz (X/Y/Z direction 2G/30 minutes)
	Cooling	Natural Cooling
Mechanic Parameters	Installation	Embedded Installation/VESA Installation
	Protection Grade	Front panel confirms to IP65(with flat cabinet installation), back

rs		cover confirms to IP20
	Mechanic Strucure	Alloy Frame
	Hole Size	380mm×245mm
	Machine Size	394mm×256mm×36mm, thinkness 22mm without expansion
	Weight	About 2250g

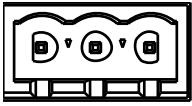
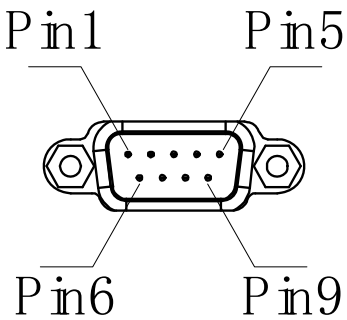
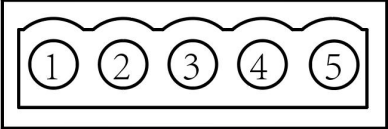
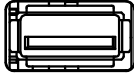
Wiring Denifition

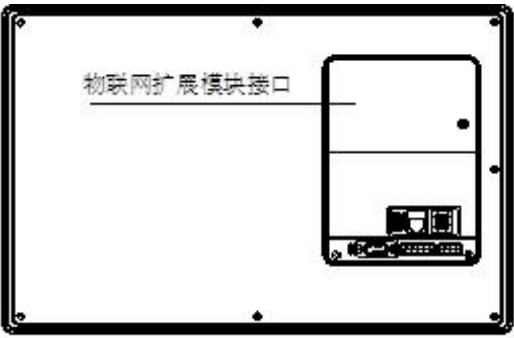
Power Terminals (Pin1~3 from left to Right)		
	Pin1	DC24V
	Pin2	GND
	Pin3	FG
DB9 Serial Ports (COM1/COM3)		
	Pin1	Rx-(B)
	Pin2	RxD (COM1 RS232)
	Pin3	TxD (COM1 RS232)
	Pin4	Tx-
	Pin5	GND
	Pin6	Rx+(A)
	Pin7	RxD (COM3 RS232)
	Pin8	TxD (COM3 RS232)
	Pin9	Tx+
COM2 Ports		
	Pin1	Rx+(A)
	Pin2	Rx-(B)
	Pin3	GND
	Pin4	Tx+
	Pin5	Tx-
USB Host		
	USB Type A	Used for connecting U-DISC and scanner etc
USB Slave		
	MicroUSB	Used for program downloading and testing
Ethernet Port		
	RJ45	Used for setting Ethernet with controller or connecting server.
FLink Expansion Module		
	Expansion Module Slot	Module Supporting: FLink FLink-2G-A FLink-4G-C FLink-4G-A FLink-WiFi-A

Size FE9156WE

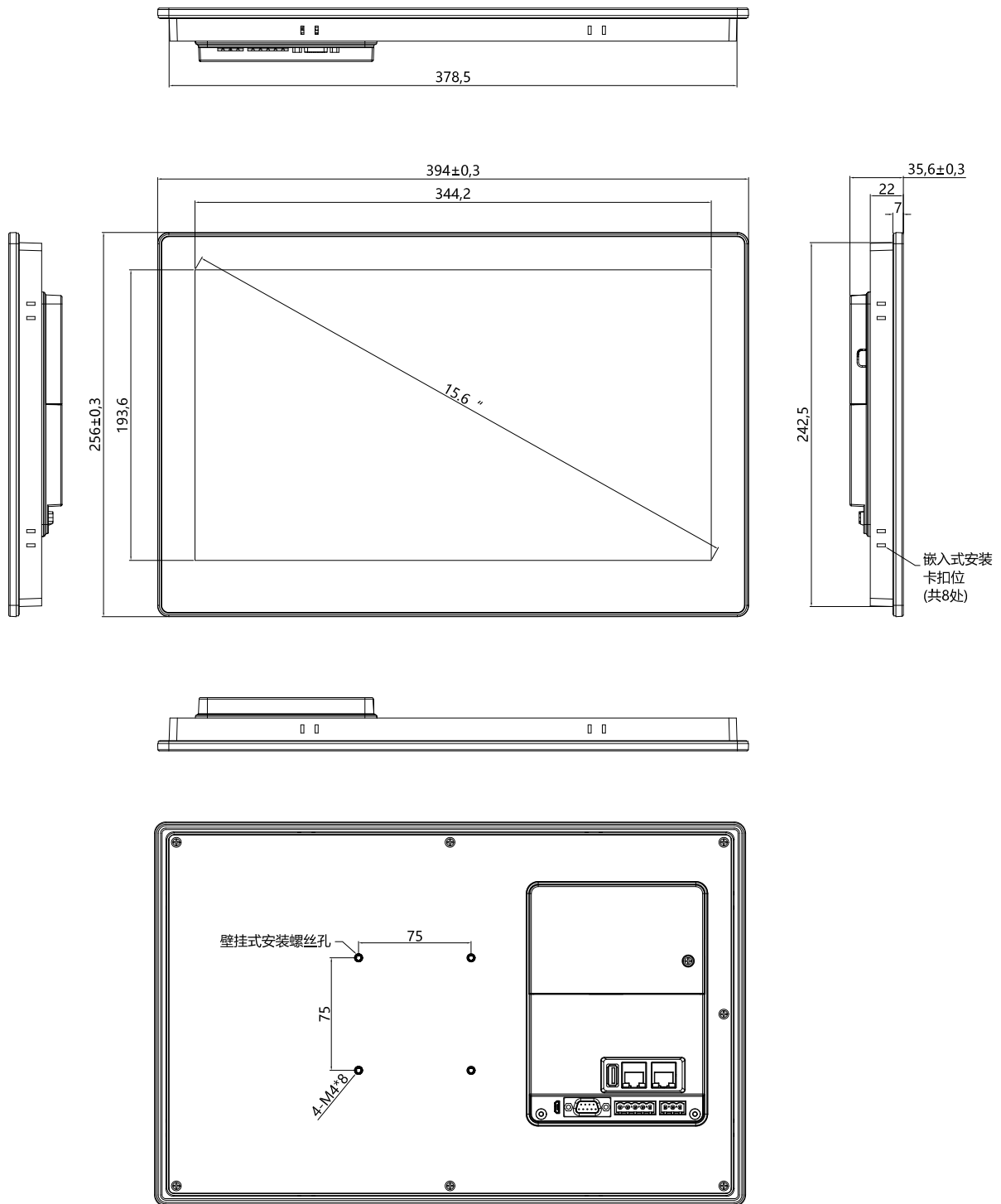

嵌入式安装开孔尺寸: 380mm*245mm

FLink Installation Diagram

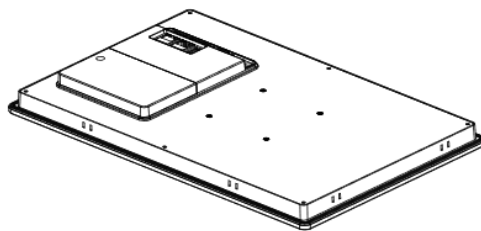
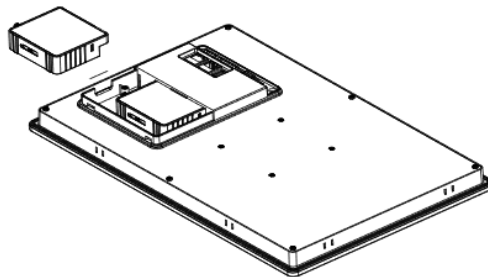
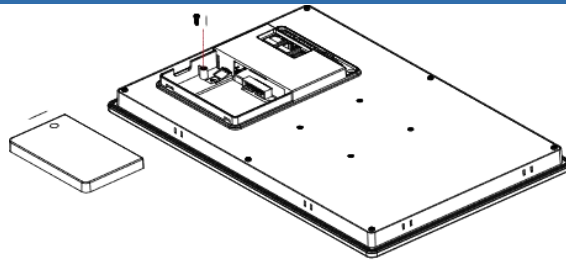

TF Card Installation Diagram

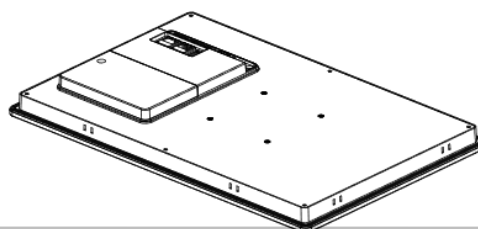
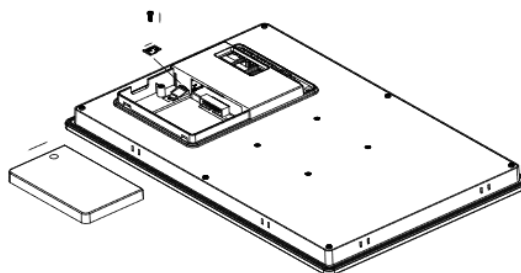

VESA Installation Diagram

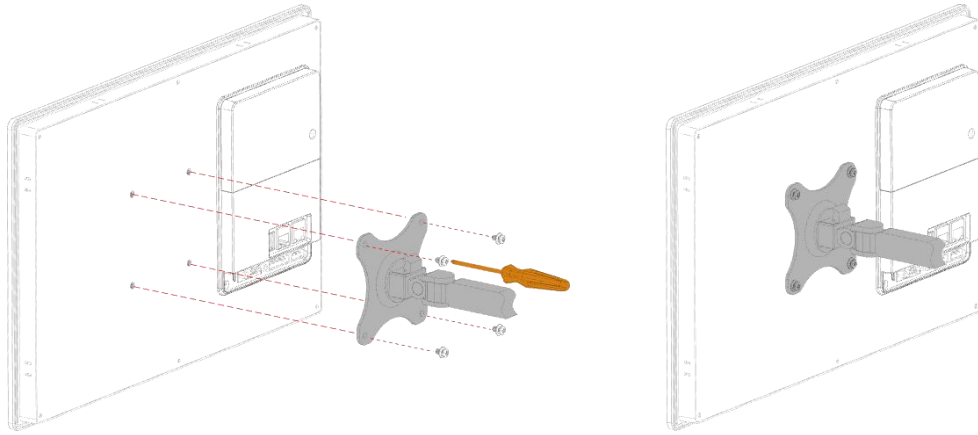

Screw PM4*8 (without frame)